

Snipe Nose Side Cutting Pliers

(Stork Beak Pliers)

DIN ISO 5745

26

Elastic tips: dimensionally stable even when twisted

- > distortion-tolerant, elastic precision tips
- > half-round, long, pointed jaws
- > with cutting edges (hardness approx. 61 HRC) for soft, medium-hard and hard wire
- > Vanadium steel, forged, multi stage oil-hardened

26 12 200 T / 26 15 200 T / 26 22 200 T / 26 25 200 T*
pliers with tether attachment point for mounting a fall protection

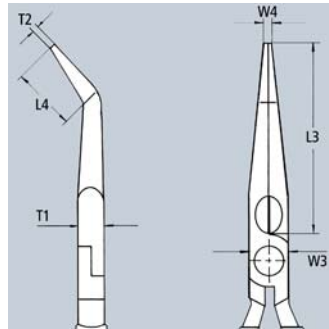
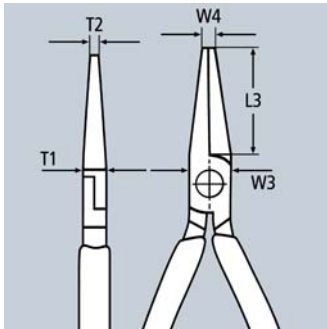
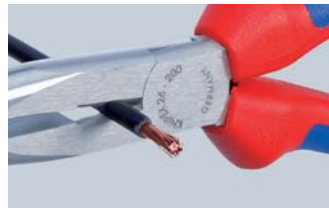

26 11 200
⊖  



26 15 200
⊖  









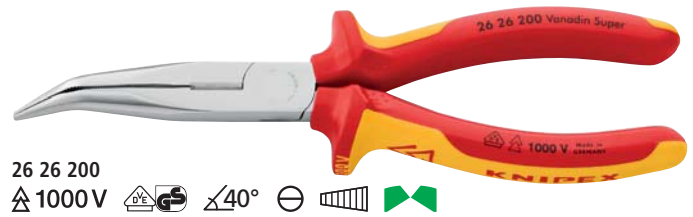

































26 22 200
∠40° ⊖  



26 25 200 T
∠40° ⊖  



26 26 200
⚡ 1000V   ∠40° ⊖  

Article No.	EAN 4003773-	↔ mm	Icons	Pliers	Head	Handles	Cutting capacities		Dimensions						
							∅ mm	∅ mm	L3 mm	L4 mm	T1 mm	W3 mm	W4 mm	T2 mm	g
26 11 200	022824	200	⊖  	black atramentized	polished	plastic coated	3.2	2.2	73.0		9.5	18.0	3.0	2.5	170
26 12 200	023142	200	⊖  	black atramentized	polished	with multi-component grips	3.2	2.2	73.0		9.5	18.0	3.0	2.5	201
26 12 200 T	079989	200	⊖  	black atramentized	polished	with multi-component grips and integrated tether attachment point	3.2	2.2	73.0		9.5	18.0	3.0	2.5	205
26 13 200	040590	200	⊖  	chrome plated		plastic coated	3.2	2.2	73.0		9.5	18.0	3.0	2.5	169
26 15 200	035022	200	⊖  	chrome plated		with multi-component grips	3.2	2.2	73.0		9.5	18.0	3.0	2.5	198
26 15 200 T	035022	200	⊖  	chrome plated		with multi-component grips and integrated tether attachment point	3.2	2.2	73.0		9.5	18.0	3.0	2.5	202
26 16 200	022831	200	⚡ 1000V   	chrome plated		insulated with multi-component grips, VDE-tested	3.2	2.2	73.0		9.5	18.0	3.0	2.5	206
26 17 200	016069	200	⚡ 1000V   	chrome plated		with dipped insulation, VDE-tested	3.2	2.2	73.0		9.5	18.0	3.0	2.5	212
26 21 200	022848	200	∠40° ⊖  	black atramentized	polished	plastic coated	3.2	2.2	73.0	23.0	9.5	18.0	3.0	2.5	171
26 22 200	023135	200	∠40° ⊖  	black atramentized	polished	with multi-component grips	3.2	2.2	73.0	23.0	9.5	18.0	3.0	2.5	197
26 22 200 T	080008	200	∠40° ⊖  	black atramentized	polished	with multi-component grips and integrated tether attachment point	3.2	2.2	73.0	23.0	9.5	18.0	3.0	2.5	201
26 25 200	035039	200	∠40° ⊖  	chrome plated		with multi-component grips	3.2	2.2	73.0	23.0	9.5	18.0	3.0	2.5	199
26 25 200 T	080015	200	∠40° ⊖  	chrome plated		with multi-component grips and integrated tether attachment point	3.2	2.2	73.0	23.0	9.5	18.0	3.0	2.5	203
26 26 200	022855	200	⚡ 1000V   ∠40° ⊖  	chrome plated		insulated with multi-component grips, VDE-tested	3.2	2.2	73.0	23.0	9.5	18.0	3.0	2.5	204
26 27 200	016090	200	⚡ 1000V   ∠40° ⊖  	chrome plated		with dipped insulation, VDE-tested	3.2	2.2	73.0	23.0	9.5	18.0	3.0	2.5	220

* Other tools with tethering can be found from page 254 ff